

EXAMPLE WIRING FOR 4-20MA OPERATION

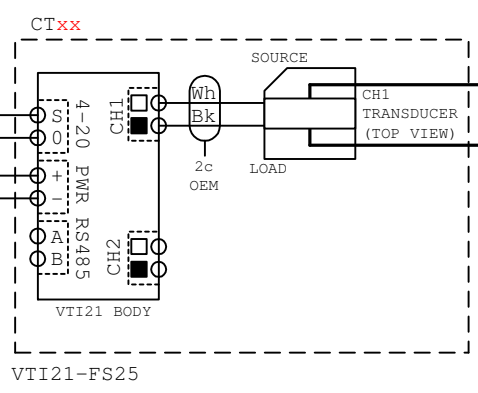

TRACK CIRCUIT RECEIVER FEED:
SOURCE - FROM RAIL
LOAD - TO FS2500 RECEIVER

To xxx SIGNALLING RAIL
To xxx RX IP

DIRECTION WHICH CONDUCTOR
PASSES THROUGH TRANSDUCER
IS IRRELEVANT

1 X VTI21 CAN MONITOR
1 X FS2500 TRACK CIRCUIT
REVEIVER IN 4-20MA MODE

CHANNEL 2 IS REDUNDANT IN 4-20MA MODE

EXAMPLE WIRING FOR RS485 OPERATION

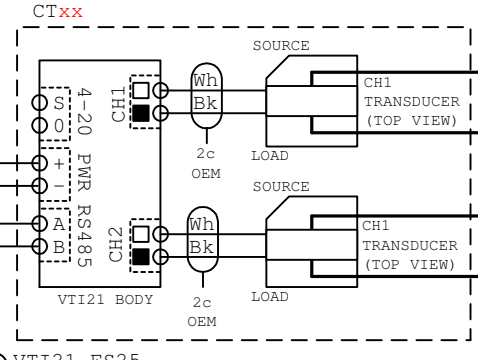

To xxx SIGNALLING RAIL

To xxx RX IP

To xxx SIGNALLING RAIL

To xxx RX IP

UP TO 7 x VTI21 OF ANY
VARIANT CAN BE ATTACHED
TO THE RS485 BUS

TRACK CIRCUIT RECEIVER FEED:
SOURCE - FROM RAIL
LOAD - TO FS2500 RECEIVER

To xxx SIGNALLING RAIL

To xxx RX IP

To xxx SIGNALLING RAIL

DIRECTION WHICH CONDUCTOR
PASSES THROUGH TRANSDUCER
IS IRRELEVANT

1 X VTI21 CAN MONITOR
2 X FS2500 TRACK CIRCUIT
REVEIVERS IN RS485 MODE

TRACK CIRCUIT RECEIVER FEED:
SOURCE - FROM RAIL
LOAD - TO FS2500 RECEIVER

Drawn:	Checked:	Produced by:	Title:	Drawing No:	MPE-VTI-003
MJB	ML		VTI21-FS25 TYPICAL CIRCUIT	Issue No.	AA1
				Issue Date:	28th Sep 2015